

Article number: 203180M16150B3VK

Description: E+G levelling foot  
GN 31-80-M16-150-B3-VK

Note: VK With nut, External hexagon at the top, Wrench flat at the bottom

## Measures

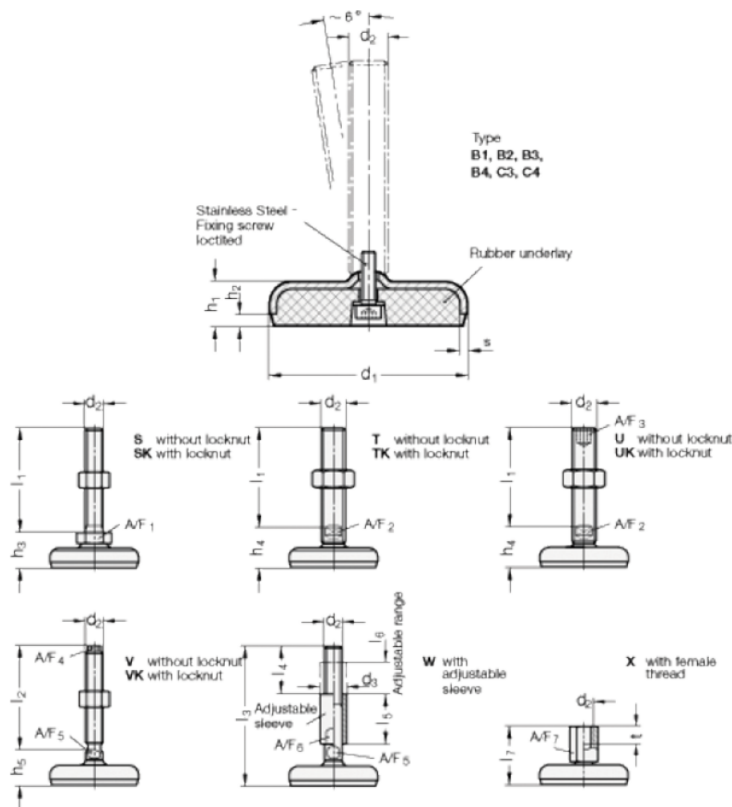

A/F4	= 10	s = 3
A/F5	= 12	
d1	= 80	
d2	= 16	
h1	= 18	
h5 +4.0/0	= 29	
l2	= 150	